

COBY®

COMPACT
disc
DIGITAL AUDIO

CX-CD410

MINI CD SYSTEM

OWNER'S MANUAL

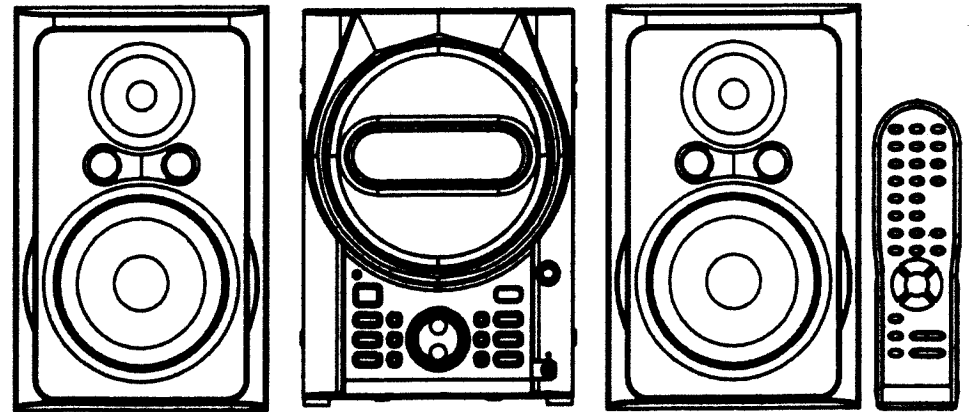

Important Safety Instructions

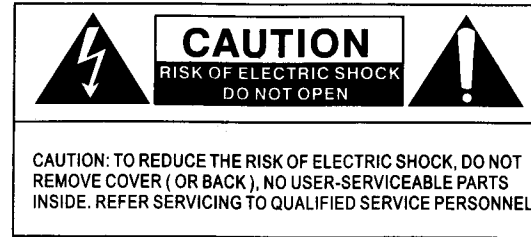

CAUTION

- Read all of these instructions.
- Save these Instructions for later use.
- Follow all Warnings and Instructions marked on the audio equipment.

- 1) **Cleaning** -- Unplug this product from the wall outlet before cleaning. Do not use liquid cleaners or aerosol cleaners. Use a damp cloth for cleaning.
- 2) **Attachments** -- Do not use attachments not recommended by the product manufacturer as they may cause hazards.
- 3) **Water and Moisture** -- Do not use this product near water: for example, near a bath tub, wash bowl, kitchen sink, or laundry tub; in a wet basement; or near a swimming pool; and the like.
- 4) **Accessories** -- Do not place this product on an unstable cart, stand, tripod, bracket, or table. The product may fall, causing serious injury to a child or adult, and serious damage to the product. Use only with a cart, stand, tripod, bracket, or table recommended by the manufacturer, or sold with the product. Any mounting the product should follow the manufacturer's instructions, and should use a mounting accessory recommended by the manufacturer.
- 5) A product and cart combination should be moved with care. Quick stops, excessive force, and uneven surface may cause the product and cart combination to overturn.
- 6) **Ventilation** -- Slots and openings in the cabinet are provided for ventilation and to ensure reliable operation of the product and to protect it from overheating, and these openings must not be blocked or covered. The openings should never be blocked by placing the product on a bed, sofa, rug, or other similar surface. This product should not be placed in a built-in installation such as a bookcase or rack unless proper ventilation is provided or the manufacturer's instructions have been adhered to.
- 7) **Power sources**-- This product should be operated only from the type of power source indicated on the marking label. If your product dealer or local power company. For products intended to operate from battery power, or other sources, refer to the operating instructions.
- 8) **Grounding or Polarization** -- This product may be equipped with a polarized alternating-current line plug (a plug having one blade wider than the other). This plug will fit into the power outlet only one way. This is a safety feature. If you are unable to insert the plug fully into the outlet, try reversing the plug.



Important Safety Instructions 2

If the plug should still fail to fit, contact your electrician to replace your obsolete outlet. Do not defeat the safety purpose of the polarize plug.

- 9) **Power- Cord or .Protection** -- Power-supply cords should be routed so that they are not likely to be walked on or pinched by items placed upon or against them, paying particular attention to cords at plugs, convenience receptacles, and the point where they exit from the product.
- 10) **Lighting** -- For added protection for this product during a lighting storm, or when it is left unattended and unused for long periods of time, unplug it from the wall outlet and disconnect the antenna or cable system. This will prevent damage to the product due to lightning and power-line surges.
- 11) **Overloading** -- Do not overload wall outlets, extension cords, or integral convenience receptacles as this can result in risk of fire or electric shock.
- 12) **Object and Liquid Entry** -- Never push objects of any kind into this product through openings as they may touch dangerous voltage points or short-out parts that could result in a fire or electric shock. Never spill liquid of any kind on the product.
- 13) **Servicing** -- Do not attempt to service this product yourself as opening or removing covers may expose you to dangerous voltage or other hazards. Refer all servicing to qualified service personnel.
- 14) **Damage Requiring Service** -- Unplug this product from the wall outlet and refer servicing to qualified service personnel under the following conditions:
 - a) when the power-supply cord or plug is damaged.
 - b) if the liquid has been spilled, or objects have fallen into the product.
 - c) if the product has been exposed to rain or water.
 - d) if the product does not operate normally by following the operating instructions. Adjust only those controls that are covered by the operating instructions as an improper adjustment of other controls may result in damage and will often require extensive work by a qualified technician to restore the product to its normal operation.
 - e) if the product has been dropped or damaged in any way.
 - f) when the product exhibits a distinct change in performance _ this indicates a need for service.
- 15) **Replacement Parts** -- When replacement parts are required, be sure the service technician has use replacement parts specified by the manufacturer or have the same characteristics as the original part. Unauthorized substitutions may result in fire, electric shock, or other hazards.
- 16) **Heat** -- the product should be situated away from heat sources such as radiators, heat registers, stoves, or other products (including amplifiers) that produce heat.

Names of Each Control (1)

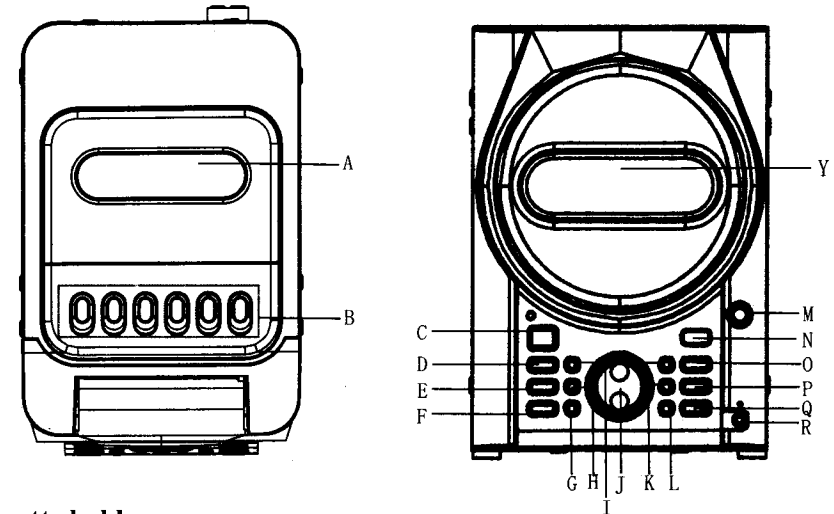

TOP

- A. **Cassette holder**
- B. **Tape transport control buttons**

FRONT

- C. **POWER button** -- Turns on and off this unit.
- The equipment draws nominal non-operating power from the AC outlet with its STANDBY/ON switch in the OFF position.
- D. **TUNING/BAND button** -- Use this button to select the tuner mode then to change AM and FM bands.
 - E. **CD/PLAY/PAUSE button** -- Use this button to select the CD mode, and start playing, press again to pause the CD.
 - F. **TAPE button** -- Use this button to select TAPE mode.
 - G. **FM ST./MONO button** -- In tuner mode, puts the tuner into mono mode typically to reduce noise in weak FM stereo signals.
 - H. **STOP button** -- Stops the CD play.
 - I. **SKIP UP/ SKIP DOWN/ TUNING buttons**
When playing a CD, use this buttons to skip tracks. Holding down either button cue review functions.
While in Tuner mode, these buttons are used to search for broadcasts.
 - J. **VOLUME button (+/-)** -- Use this button to adjust the volume level.
 - K. **REPEAT button** -- While in CD mode, this button is used to change the repeat mode, this button switches preset stations up.
 - L. **PROGRAM button** -- This button is used for program playback of CD or to preset broadcasts. Also used to change between the hours and the minutes when setting a built-in clock.
 - M. **OPEN/CLOSE button** -- This opens and closes the CD compartment lid while in CD mode.
 - N. **Remote Sensor** -- To control the unit from there mote, point it at this spot.
 - O. **RANDOM button** -- Use this button play all tracks on the CD at random.

Names of Each Control (2)

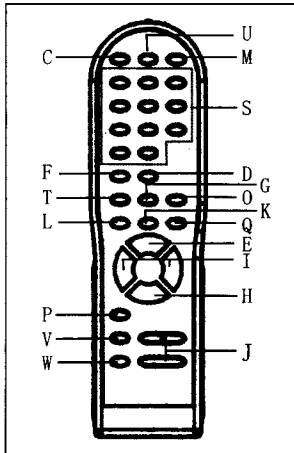

P. **SLEEP button** --Set the unit to stop and turn off after a certain time.

Q. **DISPLAY button** --To Display time.

R. **PHONES jack** -- connect optional headphones to this jack.

Remote Control

S. **Numeric buttons** -- They are use to directly access preset stations while In TUNER mode, or tracks while in CD mode.

T. **INTRO button** -- This button offers a 10-second intro-scan through CD tracks.

U. **MUTE button** -- Cuts the output to the speakers or headphones.

V. **EQ button (Electronic Equalizer Preset System)** -- this button offers Flat, Rock, Jazz, Pop and Classic modes.

W. **DBBS button (Bass Boost System)**-- Set mode to Bass Boost.

X. RESET switch

If function buttons may not work properly, do it as follow:

- A. Press the RESET switch once or twice with a pencil or a ball-point pen lightly. Unit resume work.
- B. Press the POWER button turn off the unit for 60 seconds. Unit resume work.

In the Display of the Main Unit

Y. Indicators

'STEREO' indicator lights when tuned in to a stereo FM station.

'RANDOM' indicator lights when a CD is in random play.

'INTRO' indicator lights when CD is in intro play.

'MW' or 'FM' indicator light when the unit is in Tuner mode.

'REPEAT' lights when a CD is playing in Repeat mode.

'CH' refers to a preset radio channel number.

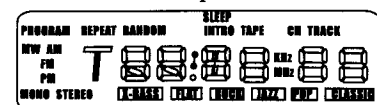

'TRACK' refers to a CD track number.

'FLAT', 'ROCK', 'JAZZ', 'POP' or 'CLASSIC' indicators are its as selected by the EQ switch.

Basic Operation

1 Adjusting the volume

The volume is adjustable between the range between 00 and 40 using the

2 VOLUME buttons. You can hold down the - or + buttons to reduce or bring up the volume continuously.

EQ (Electronic EQ Preset System)

To enjoy different sound, press the EQ button.

Every time the EQ button of the remote control unit is pressed, the mode is as follows:

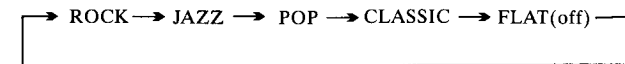

3 Muting

To cut the sound temporarily, press the MUTING button. Press the MUTING again to restore the sound. If you change the volume during the muting, the the muting will be cancel.

4 Listening through headphones

Insert the headphone plug into the PHONES jack, and adjust the volume. The sound from speakers will be cut off.

Listening to CDs

1 Press the POWER Button to turn the unit ON.

2 Press the CD button to get 'DISC' displayed.

3 Press the OPEN/CLOSE button (▲) to open the disc compartment lid.

4 Put a disc in place with the printed label facing you.

Notes

- Push the disc until it clicks in so that it securely seats on the spindle.
- Never set more than one disc.

5 Press the OPEN/CLOSE button again to close the lid.

- A moment later, the display shows the total playback time and the total number of tracks on the disc.

6 Press the PLAY/PAUSE button (▶/||) to start playback.

Playback starts from the first track.

When the playback of all the tracks has been finished, the unit stops automatically.

Repeat Playback - CD

As you press the REPEAT button, 'REPEAT' blinks, turns on solid and then goes out, the mode changing as follows:

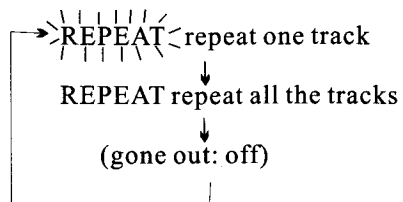

Repeat one track

Press the repeat button once during playback. The repeat indicator blinks. The track being played will be played repeatedly. If you press the SKIP button (◀◀/▶▶) and select another track, the track you selected will be played repeatedly.

It is also possible to select a track to be repeated in the stop mode. Press the REPEAT button and then select a track by pressing the SKIP button (◀◀/▶▶) or a numeric button. Press the play/pause button (▶/||) to start playback.

Repeat ALL the Tracks

All the tracks of the disc will be played repeatedly.

Press the REPEAT button twice. The repeat indicator lights steadily.

- During program playback, only the programmed tracks will be played in order repeatedly.

Random Playback - CD

Tracks can be played randomly.

If 'REPEAT' is blinking to indicate that the single track repeat function is activated, press the REPEAT button to get the indicator lit steadily or gone out.

Pressing the RANDOM button and 'RANDOM' is indicated in the display. To start random playback, press the play/pause button (▶/||).

- If you press the forward skip button (▶▶) during random play, another track is randomly selected and is played.
- If you press the backward skip button (◀◀) during random play, the current track is again played from the beginning.
- If you press the REPEAT button during random play to let 'REPEAT' blink, the current track is played repeatedly.
- To stop random play, press the stop button (■).
- To turn the RANDOM mode off, press the RANDOM button.

Programmed Playback-CD

Up to 16 tracks can be programmed in the desired order.

- Shuffle playback does not work during program playback.

1 Press the PROGRAM button in the stop mode.

'Pr:01' is displayed, along with 'PROGRAM'.

2 Press the skip (◀◀ or ▶▶) button to select a track.

3 Press the PROGRAM button

The track is programmed and 'Pr:02' is displayed.

Repeat steps 2 and 3 to program more tracks.

- You can program up to 16 tracks.
- To cancel the programming, press the STOP button (■), all the tracks you have programmed so far are cleared from memory.

4 When the selection of track numbers is completed, press the PLAY/PAUSE button (▶/||) to start program playback.

The programmed contents are kept in memory even after you have switched the unit into the TUNER or TAPE modes or the power is turned off.

5 To check the programmed order

In the stop mode, press the PROGRAM button repeatedly.

The track number will be shown on the display.

6 To add a track to the end of the program

In the stop mode, press the PROGRAM button repeatedly until ' -- ' is displayed to the right of a program number.

Select a track number by pressing the SKIP button (◀◀ or ▶▶) and then press the PROGRAM button.

The track is added to the end of the program.

7 To overwrite the program

In the stop mode, press the PROGRAM button repeatedly until the track number to be changed appears on the display.

Select a new track number by pressing the SKIP button (◀◀ or ▶▶) and then press the PROGRAM button.

8 To clear the program

To clear the program contents, press the STOP button (■) in the stop mode. Pressing the OPEN/CLOSE button also clears the programmed contents.

- If the unit is disconnected from the power supply, the programmed contents will be cleared.

Listening to Radio Programs

- 1 Press the **TUNING/BAND** button.
- 2 To select the band (AM or FM), press the **TUNING/BAND** button again.
- 3 Select a station.
Hold down the **TUNING** button (∨ or ∧) for a while and release the button. When a station is tuned in, the tuning stops automatically. Repeat this step until the desired station is found. Press the **TUNING** button to stop the tuning.
 - To select stations which cannot be tuned automatically, press the **TUNING** button repeatedly.
 - "STEREO" is displayed when a stereo broadcast is tuned in.
- 4 If the reception is poor
press the **FM ST./MONO** button.
The unit is turned to mono mode, but the reception will improve.
For a good reception, turn around the antenna so that you can get the station clearly.

Storing Preset Stations

- Up to 20 FM and 12 AM stations can be stored in preset memories.
- 1 Pressing the **TUNING/BAND** to select FM or AM.
 - 2 Press the **TUNING** button and tune in a station to be stored as a preset station and then press the **PROGRAM** button.
 - 3 Select a preset channel to store the station by pressing the **REPEAT** button or a numeric button, and then press the **PROGRAM** button.
Remember not to overwrite a preset channel. It is wise of you to write down which stations are stored in which channels.

To store more stations, repeat step 1 to 3.
 - 4 How to select preset stations
press the **REPEAT** button or numeric buttons to select a preset channel.

Listening to Tapes

The tape transport cannot be controlled from the remote control unit..

- 1 Insert a cassette tape.
Press the **STOP/EJECT** button to open the cassette holder, load a cassette with its exposed side facing you, and close the cassette holder by pushing it.
- 2 Press the **TAPE** button to select "TAPE".
- 3 Press the **PLAY** buttons (▶).
- 4 To stop playback ---press the **STOP/EJECT** button (■/▲) to stop play back.
- 5 To pause in the playback --- press the **PAUSE** button (⏸). To resume playback, press the button again.
- 6 Fast forward and rewind---press the **F Forward**(▶▶) or the **REW**(◀◀) button. press the **STOP/EJECT**(■/▲) button to stop the fast forward or rewind operation.
- 7 To take out the cassette tape---press the **Stop/EJECT** (■/▲) button to stop playback then press the button again to open the cassette holder.

Tape Recording

- 1 Load a recordable cassette tape into the cassette holder.
- 2 Select the source to be recorded by pressing the **TUNER** or the **CD** button
- 3 Press the **RECORD** button (●).
The record button is locked to the **PLAY** button: When the **RECORD** button is pressed down, the **PLAY** button also is.

The recording starts
 - It is possible to record during random playback or program playback.
- 4 To stop recording
Press the **STOP/EJECT** button (■/▲).

Clock Adjustment

The clock can be adjusted whether the unit is turned on or off.

1 If the unit is turned on, press the DISPLAY button.

You need to press the switch twice if a CD is currently playing.

2 Press the PROGRAM button.

The hours start blinking.

3 Press the skip/TUNING buttons as many times as necessary to enter the number of hours, and then press the PROGRAM button.

The minutes start blinking.

4 Similarly with the hours, press the skip/TUNING buttons as many times as necessary to enter the number of minutes, and then press the PROGRAM button.

Using the sleep

Set the unit to stop and turn off after a certain time.

1 While enjoying the desired source-- Press SLEEP button to select the desired time.

2 TO cancel the SLEEP-- Press SLEEP button to select OFF.

3 To confirm the remaining time.(only while unit is ON)-- Press SLEEP button, the remaining time is shown for about 10 seconds.

4 To change the setting -- Press SLEEP button to select the new setting.

Note

- The play and sleep can be used together.
- The sleep always has priority.

Trouble Shooting

In case of trouble with the unit, please take the trouble to look through this chart and see if you can solve the problem yourself before you call your dealer.

General

No power

- Check the connection to the Ac power supply.

No sound from speakers.

- Check the connection to the speakers.
- Adjust the volume.
- Select proper source.
- Pull out the headphones, plug from PHONES jack.
- If muting is on, press the MUTING button.

The sound is noisy.

- The unit is too close to a TV set or similar appliances. Install the unit apart from them, or turn them off.

Remote Control Unit

Remote control does not work.

- If the batteries are exhausted, change the batteries.
- Use remote control unit within the range and point at the front panel.
- Clear obstacles between the remote control unit and the main unit.
- If a fluorescent light is near the unit, put it off.

Cassette Tape Deck

The cassette holder cannot be closed.

- Insert a cassette tape securely with its exposed side facing you.

No sound. Sound is distorted or noisy.

- If a blank tape is loaded, replace it with a prerecorded tape.
- Clean and demagnetize the heads.

Can not record

- If the safety tabs of the cassette tape have been broken off, cover the holes with adhesive tape.
- Clean and demagnetize the heads.
- Use normal tapes.

Tuner

Can not listen to any station, or signal is too weak.

- Tune in the station properly.
- If a TV is near the unit, put it off.
- Re-orient the antenna until reception improves.

Though the broadcast is stereo, It sounds monaural.

- Press the FM MODE button.

CD Player

Can not play.

- Load a disc with label side facing you.
- If the disc is dirty, clean the Surface of the disc.

One track is played repeatedly.

- Press the REPEAT button to cancel the repeat mode.

Sound skips.

- Place the unit on a stable place to avoid vibration and shock.
- If the disc is dirty, clean the Surface of the disc.
- Do not use scratched, damaged or warped discs.

Specifications

CD Player

Pickup	3-beam pick-up
Wavelength	790 nm
Audio Frequency response	20 Hz ~ 20 KHz

Cassette deck

Track System	2-channel stereo
Tape Speed	4.76cm/sec
Wow and Flutter	0.4% or less

Tuner

System	PLL quartz-locked digital synthesizer system
FM tuning range	87.90 ~ 107.90MHz
AM tuning rang	520-1710 KHz
Antenna	FM pigtail antenna AM bar antenna (built-in)

General

Output power	50W x 2 @ 10% THD
Power requirements	110/220V- 60Hz/50Hz
Power consumption	25W
Dimensions(WxHxD)	5-7/8" x 8-1/2" x 8-3/4" (150x217x223mm)
Weight	(2.20kg)
Supplied accessories	Remote control unit x1

Speaker

System	2-way shielded box
Impedance	4 ohm
Dimensions(WxHxD)	5-1/2" x 8-3/4" x 6" (140 x221.5 X151.7 mm)
Weight	1.25kg

- Design and specifications are subject to change without notice.
- Photos and illustrations may differ slightly from production models.

COBY®

90 DAY LIMITED WARRANTY

COBY ELECTRONICS CORP. ("COBY") warrants this product to the original purchaser to be free from defects in material or workmanship under normal use for 90 DAYS from the date of original purchase. COBY agrees at our option under this warranty, to repair or replace it with a new or reconditioned product at no additional charge. Our warranty, of course, does not cover any product which has been subject to neglect, unreasonable use, accident, violation of operating instructions, or any product that has been repaired or modified by an unauthorized service agent.

To obtain factory service, return this unit freight-prepaid to the address shown below within the duration of this warranty. Enclose \$6.00 for each item in the form of money order made payable to **COBY ELECTRONICS CORP.** To cover the cost of postage and handling. Also, include a copy of the sales receipt to show the proof of purchase and a detailed description of the problem. The unit(s) must be packaged in such away as to reasonably protect it from possible shipping damage. For further information write to:

COBY ELECTRONICS CORP.
Customer Service Dept.
56-65 Rust Street
Maspeth, N.Y. 11378

COBY's liability under any legal theory for any loss or damage in any way related to this product shall in no event exceed the sale price of this product. In no event shall COBY be liable for any incidental or consequential damages resulting from the use of, or inability to use this product. Repair or replacement as provided under this warranty is the exclusive remedy of the consumer. Except to the extent prohibited by law, no express or implied warranty of merchantability or fitness for a particular purpose on this product shall not extend beyond the period of this warranty. Some states prohibit the exclusion or limitation of incidental or consequential damages, so that the above limitations or exclusion may not apply to you. This warranty gives you specific rights, and you may also have other rights which may vary from state to state.